

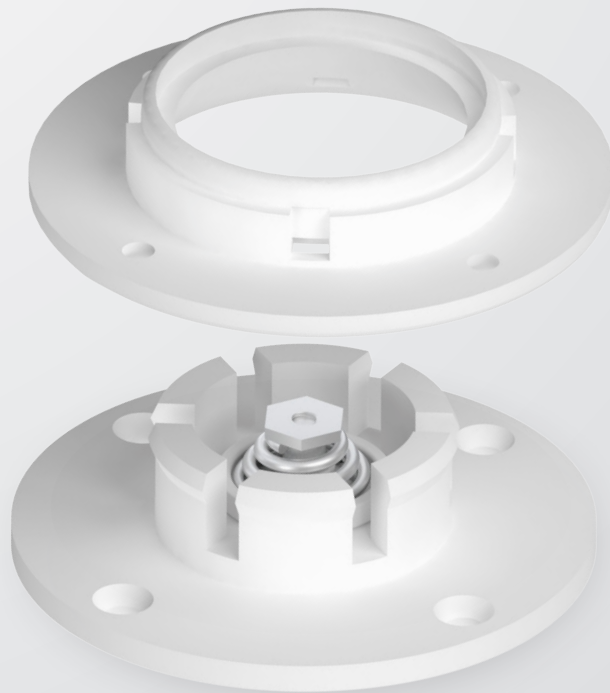











# FITLOCK

*FIT YOUR NEEDS, GET OUR SYSTEM*

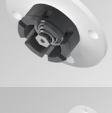

Listino prezzi  
*Price list*

# Gamma Fitlock / Fitlock Series

Articolo Item	Descrizione description	Confezione (pz) units x pack	Prezzo unitario pz price
	FLS	100	2,89
	Fitlock soft		
	FLH	100	2,89
	Fitlock hard		
	FLSH	100	2,89
	Fitlock super hard		
	FL_F	100	0,97
	Fitlock female		
	FLS_M	100	1,92
	Fitlock soft male		
	FLH_M	100	1,92
	Fitlock hard male		
	FLSH_M	100	1,92
	Fitlock super hard male		
	FLEVOS	100	3,03
	Fitlock evo soft		
	FLEVOH	100	3,03
	Fitlock evo hard		
	FLEVO_F	100	1,11
	Fitlock evo female		
	FLEVOS_M	100	1,92
	Fitlock evo soft male		
	FLEVOH_M	100	1,92
	Fitlock evo hard male		
	MFLS	100	2,89
	Mini fitlock soft		

# Gamma Fitlock / Fitlock Series

Articolo Item	Descrizione description	Confezione (pz) units x pack	Prezzo unitario pz price
	MFLH	100	2,89
	Mini fitlock hard		
	MFLSH	100	2,89
	Mini fitlock super hard		
	MFL_F	100	0,97
	Mini fitlock female		
	MFLS_M	100	1,92
	Mini fitlock soft male		
	MFLH_M	100	1,92
	Mini fitlock hard male		
	MFLSH_M	100	1,92
	Mini fitlock super hard male		
	MFLEVOS	100	3,03
	Mini fitlock evo soft		
	MFLEVOH	100	3,03
	Mini fitlock evo hard		
	MFLEVOSH	100	3,03
	Mini fitlock evo super hard		
	MFLEVO_F	100	1,11
	Mini fitlock evo female		
	MFLEVOL	100	3,94
	Mini fitlock evo alloy		
	MFLEVOL_F	100	1,19
	Mini fitlock evo alloy female		
	MFLEVOL_M	100	2,75
	Mini fitlock evo alloy male		



# Gamma Fitlock / Fitlock Series

Articolo Item	Descrizione description	Confezione (pz) units x pack	Prezzo unitario pz price
	FLI	100	4,96
	Fitlock inox		
	FLZ	100	4,35
	Fitlock inox galvanized		
	FLI_F	100	1,57
	Fitlock inox female		
	FLZ_F	100	1,21
	Fitlock inox female galvanized		
	FLI_M	100	3,39
	Fitlock inox male		
	FLZ_M	100	3,14
	Fitlock inox male galvanized		
	FLIF	100	4,96
	Fitlock inox free		
	FLZF	100	4,35
	Fitlock inox free galvanized		
	FLIF_F	100	1,57
	Fitlock inox free female		
	FLZF_F	100	1,21
	Fitlock inox free female galvanized		
	MFLCS	100	2,55
	Mini fitlock colpo soft		
	MFLCH	100	2,55
	Mini fitlock colpo hard		
	MFLC35S	100	2,55
	Mini fitlock colpo 35 mm soft		

# Gamma Fitlock / Fitlock Series

Articolo Item	Descrizione description	Confezione (pz) units x pack	Prezzo unitario pz price
	MFLC35H	100	2,55
	Mini fitlock colpo 35 mm hard		
	MFLC_F	100	0,63
	Mini fitlock colpo female 30 mm		
	MFLC35_F	100	0,63
	Fitlock colpo 35 mm female		
	MFLCCS	100	2,55
	Mini fitlock colpo colpo soft		
	MFLCCH	100	2,55
	Mini fitlock colpo colpo hard		
	MFLCC35S	100	2,55
	Mini fitlock colpo colpo soft (35 mm female)		
	MFLCC35H	100	2,55
	Mini fitlock colpo colpo hard (35 mm female)		
	MFLCS_M	100	1,92
	Mini fitlock colpo soft male		
	MFLCH_M	100	1,92
	Mini fitlock colpo hard male		
	MFLBASES_M	500	0,82
	Mini fitlock soft male base		
	MFLBASEH_M	500	0,82
	Mini fitlock hard male base		
	AZFLS	100	3,39
	AZ Fitlock soft		
	AZFLH	100	3,39
	AZ Fitlock hard		

# Gamma Fitlock / Fitlock Series

Articolo Item	Descrizione description	Confezione (pz) units x pack	Prezzo unitario pz price
	AZFLSH	100	3,39
	AZ Fitlock super hard		
	AZFLS_M	100	1,92
	AZ Fitlock soft maschio		
	AZFLH_M	100	1,92
	AZ Fitlock hard maschio		
	AZFLSH_M	100	1,92
	AZ Fitlock super hard maschio		
	AZFL_F	100	1,92
	AZ Fitlock femmina		
	AZMFLS	100	3,39
	AZ mini fitlock soft		
	AZMFLH	100	3,39
	AZ mini fitlock hard		
	AZMFLSH	100	3,39
	AZ mini fitlock super hard		
	AZMFL_F	100	1,47
	AZ mini fitlock femmina		
	AZMFLS_M	100	1,92
	AZ mini fitlock soft maschio		
	AZMFLH_M	100	1,92
	AZ mini fitlock hard maschio		
	AZMFLSH_M	100	1,92
	AZ mini fitlock super hard maschio		
	MFLBUILDS_M	100	1,92
	Mini fitlock build soft maschio		

# Gamma Fitlock / Fitlock Series

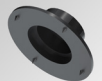

Articolo Item	Descrizione description	Confezione (pz) units x pack	Prezzo unitario pz price
	MFLBUILDH_M	100	1,92
	CAI4	100 coppie	1,30 (coppia)
		Coupling fitting pair 4 mm	1,30 (couple)
	CAI6	100 coppie	1,45 (coppia)
		Coupling fitting pair 6 mm	1,45 (couple)
	PQ4	200	0,65
	PQ6	200	0,72
	CAI4	25 coppie	2,75
		Coupling fitting pair alloy 4 mm	
	CAI6	25 coppie	3,62
		Coupling fitting pair alloy 6 mm	
	PQ4	50	1,67
	PQ6	50	1,94
	FLKU	100	1,30
	M	100	0,97
	MM	100	0,97
	DI	500	0,10

## Gamma Fitlock / Fitlock Series





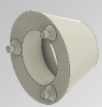
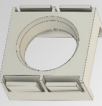







Articolo Item		Descrizione description	Confezione (pz) units x pack	Prezzo unitario pz price
	D2	Anello distanziale per fitlock 2 mm	500	0,10
		Spacer ring for fitlock 2 mm		
	MD1	Anello distanziale per mini fitlock 1 mm	500	0,10
		Spacer ring for mini fitlock 1 mm		
	MD2	Anello distanziale per mini fitlock 2 mm	500	0,10
		Spacer ring for mini fitlock 2 mm		
	MD3	Anello distanziale per mini fitlock 3 mm	250	0,10
		Spacer ring for mini fitlock 3 mm		
	MD5	Anello distanziale per mini fitlock 5 mm	250	0,10
		Spacer ring for mini fitlock 5 mm		
	P	Tappo di protezione per Fitlock	100	0,43
		Protection Cap		
	MP	Tappo di protezione per Fitlock piccolo	100	0,38
		Mini Protection Cap		
	LMP	Tappo protezione Mini Lega	100	0,38
		Mini Protection Cap Alloy		
	MR	Manopola di regolazione Fitlock evo	10	4,32
		Adjusting Knob Fitlock evo		
	MMR	Manopola di regolazione mini Fitlock evo	10	4,32
		Adjusting Knob		
	TFLF	Tappo femmina Fitlock	100	0,50
		Protection Cap female		
	LD1	Anello distanziale in lega evo (0-2 mm)	100	0,78
		Anello distanziale in lega evo (0-2 mm)		
	LD2	Anello distanziale in lega evo (1-3 mm)	100	0,94
		Anello distanziale in lega evo (1-3 mm)		

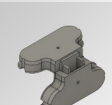

## Gamma Fitlock / Fitlock Series

Articolo Item		Descrizione description	Confezione (pz) units x pack	Prezzo unitario pz price
	TMBUILD	Chiave di montaggio Mini Fitlock Build	1	3,00
		Mini Fitlock Build Mounting key		
	FLBARRAF	Aggancio per barra FITLOCK® FEMMINA	50	1,39
		Bar fitting Fitlock® FEMALE		
	FLEGOF	Aggancio FITLOCK® laterale per barra femmina	100	1,39
		Side FITLOCK® fitting for female bar		
	BBA	Innesto a baionetta per barra	100	1,65
		Bayonet connection for bar		

## Gamma varie Fitlock / Fitlock various Series

Articolo Item	Descrizione description	Confezione (pz) units x pack	Prezzo unitario pz price
	FITKITE	12	16,00
	Cavetto d'ispezione retrattile Retractable inspection cable		
	FITKITEF	8	18,50
	Cavetto d'ispezione retrattile con staffa per montaggio laterale Retractable inspection cable with bracket for side mounting		
	FKG	12	1,50
	Gancio per cavetto per ispezione retrattile Retractable inspection cable hook		
	SSFL	1	2,50
	Staffa supporto Fitlock Fitlock bracket		
	SSMFL	1	2,50
	Staffa supporto Mini Fitlock Mini Fitlock bracket		
	PFFL	1	490
	Punta fresa montaggio Drill bit mounting		
	PFMFL	1	460
	Punta fresa montaggio Drill bit mounting		
	FBB	100	1,30
	Fitblock Fitblock		
	FBB90	100	1,30
	Fitblock 90° Fitblock 90°		
	FBLB	12	6,37
	Fitblock Lega Fitblock Alloy		
	FJE	6	21,60
	Fitjump Evo Fitjump Evo		
	FJES	6	23,76
	Fitjump Evo Sospeso Fitjump Evo Suspended		
	FJB	1	5,00
	Barra Fitjump - L 120 cm Fitjump Bar - L 120 cm		







## Gamma varie Fitlock / Fitlock various Series

Articolo Item	Descrizione description	Confezione (pz) units x pack	Prezzo unitario pz price
	FS	1	65,00
	Fitspin		
	FSPA	1	16,50
	Cover in alluminio satinato FS - L 250 cm		
	FSA4	1	3,80
	Asta Ø 4 mm - L 200 cm		
	BR30H50	1	58,00
	Base regolabile laterali (destra+sinistra)		
	BR40H50	1	61,00
	Base regolabile laterali (destra+sinistra)		
	BR50H50	1	64,00
	Base regolabile laterali (destra+sinistra)		
	BR60H50	1	68,00
	Base regolabile laterali (destra+sinistra)		
	BR30CH50	1	58,00
	Base regolabile centrale		
	BR40CH50	1	61,00
	Base regolabile centrale		
	BR50CH50	1	32,00
	Base regolabile centrale		
	BR60CH50	1	34,00
	Base regolabile centrale		
	PRF	1	8,80
	Piedino con regolazione frontale		
	S10PM	1	1,08
	Spessore piedino 10mm		

## Gamma varie Fitlock / Fitlock various Series

Articolo Item	Descrizione description	Confezione (pz) units x pack	Prezzo unitario pz price
	S25PM	1	1,30
	Spessore piedino 25 mm 25 mm foot spacer		
	S50PM	1	1,62
	Spessore piedino 50 mm 50 mm foot spacer		
	FCSAV	6	21,06
	Fitlock + marcatore Fitlock + marker		
	MFCE	1	1,50
	Dima marcatrice per aggancio esterno Marking template for external fitting		
	MFCI	1	1,50
	Dima marcatrice per aggancio incassato Marking template for recessed fitting		
	FCSAVCVC	1	12,96
	Cover metallica Metal cover		
	FCSAVR	6	28,08
	Fitlock regolabile + cacciavite dedicato Adjustable Fitlock + dedicated screwdriver		
	FCSAVPIDX	1	11,00
	Cover Destra Right Cover		
	FCSAVPISX	1	11,00
	Cover Sinistra Left Cover		
	AF150NS	1	36,72
	Fitlimiter asta 150 mm nichel satinato Fitlimiter 150 mm rod satin nickel		
	AF200NS	1	38,34
	Fitlimiter asta 200 mm nichel satinato Fitlimiter 200 mm rod satin nickel		
	AF250NS	1	39,96
	Fitlimiter asta 250 mm nichel satinato Fitlimiter 250 mm rod satin nickel		
	AF300NS	1	41,58
	Fitlimiter asta 300 mm nichel satinato Fitlimiter 300 mm rod satin nickel		



## Gamma varie Fitlock / Fitlock various Series

Articolo Item	Descrizione description	Confezione (pz) units x pack	Prezzo unitario pz price
	AF150CL	1	36,72
	Fitlimiter asta 150 mm cromo lucido Fitlimiter 150 mm rod polished chrome		
	AF200CL	1	38,34
	Fitlimiter asta 200 mm cromo lucido Fitlimiter 200 mm rod polished chrome		
	AF250CL	1	39,96
	Fitlimiter asta 250 mm cromo lucido Fitlimiter 250 mm rod polished chrome		
	AF300CL	1	41,58
	Fitlimiter asta 300 mm cromo lucido Fitlimiter 300 mm rod polished chrome		
	CI	25	8,80
	Cavo ispezione Inspection cable		
	CIS	25	8,80
	Cavo ispezione small Small Inspection cable		













# Grigliati / Grids

Articolo Item		Descrizione description	Confezione (pz) units x pack	Prezzo/pz
	FGB	Barra in alluminio lunghezza 2,5m - sez. 78 x 25 mm	1	23,00
		Aluminium bar 2,5 m - sec. 75 x 25 mm		
	FGBQ	Barra in alluminio lunghezza 2,5m - sez. 25 x 25 mm	1	14,00
		Aluminium bar 2,5 m. - sec. 25 x 25 mm		
	FGBSP	Barra alluminio supporto pannelli	1	6,00
		Aluminum panel support bar		
	FGBQB	Barra in alluminio lunghezza 2,5m sez. 15x25 mm	1	9,00
		Aluminum bar length 2,5m - sect. 15x25 mm		
	FGABALUH250F	Barra fitgarden alluminio 78x40mm 2,5m	1	32,00
		Aluminum fitgarden bar 78x40mm 2,5m		
	FFBALU270F	Barra longitudinale in alluminio 270 cm, forata	1	34,00
		Longitudinal aluminium bar 270 cm, perforated		
	FFBALU48F	Barra per griglia lunghezza 49 cm, forata	1	11,00
		Bar for grating length 49 cm, perforated		
	FFBALUH270F	Barra longitudinale alta in alluminio 270 cm, forata	1	43,00
		High longitudinal aluminium bar 270 cm, perforated		
	FFBALUH48F	Barra per griglia alta lunghezza 49 cm, forata	1	12,50
		Bar for high grating length 49 cm, perforated		
	FFBALU270A	Barra longitudinale in alluminio 270 cm, con 9 ammortizzatori	1	84,00
		Longitudinal aluminium bar 270 cm, with 9 dampers		
	FFBALUH270A	Barra longitudinale alta in alluminio cm 270 con 9 ammortizzatori	1	90,00
		High longitudinal bar in aluminium cm 270 with 9 shock absorbers		
	FFSTIBALUG	Staffa incrocio barra con gomma anticontatto	50	2,50
		Bar cross bracket with protective rubber		
	FGCP	Incrocio in plastica per barra in alluminio 78x25 mm	100	1,05
		Plastic cross fitting for 78x25 mm aluminium bar		

# Grigliati / Grids

Articolo Item	Descrizione description	Confezione (pz) units x pack	Prezzo/pz
	FGCPQ	100	0,81
	Incrocio in plastica per barra in alluminio 25 x 25 mm Plastic cross fitting for 25 x 25 mm aluminium bar		
	FGCA	50	2,59
	Incrocio in alluminio per barra in alluminio 78x25 mm Aluminium cross fitting for 78x25 mm aluminium bar		
	FGLEGO	100	1,46
	Incrocio in plastica per barra in alluminio 78x25 mm Fitlego Plastic cross fitting for Fitlego 78x25 mm aluminium bar		
	SQGP	25	3,78
	Salto di quota per barra 78x25 / 25 x 25 mm Angle piece for 78x25 / 25 x 25 mm bar		
	SQGG	25	4,86
	Salto di quota per barra 78x25 mm Angle piece for 78x25 mm bar		
	SQP	25	4,32
	Salto di quota per barra 25 x 25 mm Angle piece for 25 x 25 mm bar		
	FGBLA	100	1,94
	Barretta di giunzione in alluminio salto quota positivo (per art.Fgb) Aluminium junction bar for positive angle piece (item Fgb)		
	FGBLB	100	1,94
	Barretta di giunzione in alluminio salto quota negativo (per art.Fgb) Aluminium junction bar for negative angle piece (item Fgb)		
	FFBG	100	2,15
	Barretta di giunzione in alluminio Alluminium junction bar		
	FFBGP	250	0,60
	Barretta di giunzione in plastica Plastic junction bar		
	FGVA	2000	0,38
	Vite a t in acciaio completa di dado T-shaped screw in steel complete with nut		
	FFSER25	100	4,70
	Dumper Dumper		
	FGASA	12	2,50
	Aggancio di supporto zampa-barra ammortizzato Support hook leg-bar cushioned		

# Grigliati / Grids

Articolo Item	Descrizione description	Confezione (pz) units x pack	Prezzo/pz
	FGASR	12	0,80
	Aggancio di supporto zampa-barra rigido Rigid leg-bar support hook		
	FFPZ100	200	1,95
	Piede filettato h 100 mm Threaded foot h 100 mm		
	FFPZ60	100	1,65
	Piedino fisso da incollare mm 60 Fixed foot to be glued mm 60		
	FGAPP	12	8,00
	Piedino Prato a piantare escursione max 110mm Lawn foot to plant excursion max 110mm		
	FGAP	24	2,00
	Piedino Prato escursione max 50mm Lawn foot to plant excursion max 50mm		
	FGAPM	24	1,80
	Piedino Prato Mini escursione max 20mm Lawn foot to plant excursion max 20mm		
	FGAC35	12	3,50
	Canotto di prolunga 35mm Extension tube of 35mm		
	FGAC70	12	3,80
	Canotto di prolunga 70mm Extension tube of 70mm		
	FGAC125	12	4,30
	Canotto di prolunga 125mm Extension tube of 125mm		
	FGAC225	12	5,50
	Canotto di prolunga 225mm Extension tube of 225mm		
	FGAC325	12	6,50
	Canotto di prolunga 325mm Extension tube of 325mm		
	FGSF	12	2,50
	Aggancio con manopola con perno 8 x 7 mm Coupling with knob with 8 x 7 mm pin		
	FGSF	12	2,50
	Aggancio con manopola con perno 8 x 17 mm Coupling with knob with 8 x 17 mm pin		



# Grigliati / Grids

Articolo Item		Descrizione description	Confezione (pz) units x pack	Prezzo/pz
	FGACLIP	Clip per doga 78 mm	100	0,90
		Clip for stave 78 mm		
	FGAFCLIP	Clip terminale per doga 78 mm	100	0,90
		End clip for stave 78 mm		
	FGAMCLIP	Clip per doga 25 mm	100	0,70
		Clip for stave 25 mm		
	FGAMFCLIP	Clip terminale per doga 25 mm	100	0,70
		End clip for stave 25 mm		
	FGSBA	Supporto antivibrante con perno M8 per barra in alluminio sez. 78x25 mm	100	7,60
		Anti-vibrating support with M8 pin for bar in aluminium sec. 78 x 25 mm		
	FGSBA10	Supporto antivibrante con perno M10 per barra in alluminio sez. 78x25 mm	100	7,60
		Anti-vibrating support with M10 pin for bar in aluminium sec. 78 x 25 mm		
	FGQSBA	Supporto antivibrante con perno M8 per barra in alluminio sez. 25 x 25 mm	50	5,40
		Anti-vibrating support with M8 pin for bar in aluminium sec. 25 x 25 mm		
	FGQSBA10	Supporto antivibrante con perno M10 per barra in alluminio sez. 25 x 25 mm e 78x25 mm	50	5,40
		Anti-vibrating support with M10 pin for bar in aluminium sec. 25 x 25 mm and 78 x 25 mm		
	FW	Fitwall M8	100	7,60
		Fitwall M8		
	FW10	Fitwall M10	100	7,60
		Fitwall M10		
	FWR	Borchia con regolatore M 8 per fissaggio pannelli	100	3,02
		Stud with regulator M 8 for fixing panels		
	FWP15	Pernio per borchia regolabile mm 15	100	0,38
		Pin for adjustable stud 15 mm		
	FWP20	Pernio per borchia regolabile mm 20	100	0,41
		Pin for adjustable stud mm 20		

## Grigliati / Grids

Articolo Item		Descrizione description	Confezione (pz) units x pack	Prezzo/pz
	FWP25	Pernio per borchia regolabile mm 25	100	0,43
		Pin for adjustable stud mm 25		
	FWP40	Pernio per borchia regolabile mm 40	100	0,50
		Pin for adjustable stud mm 40		

# NOTES

## 1. Introduction

These general conditions of sale are published in official DAUREKA S.R.L. documents, including catalogue, price list, website, etc.

Therefore, they are considered as known to the client and all orders include implicit acceptance of same.

DAUREKA S.R.L. reserves the right to make any changes it deems fit to these general conditions of sale.

These conditions are valid until the issue and publication of new conditions, which will annul and supersede all previous conditions of sale.

The contents, copyright and all other rights over DAUREKA S.R.L. products and materials, and relevant documents (catalogues, price lists, website, etc.) are the property of DAUREKA S.R.L..

It is permitted to view, download and reproduce information and materials data sheets only for internal use by the client and provided that:

- all contents of official documents are kept
- only images with surrounding texts relevant to same are used
- the copyright warning is included: "© FITLOCK - All rights reserved"

It is not permitted to make copies, publication or commercial use other than as listed above without the explicit consent of DAUREKA S.R.L..

## 2. Product and prices

- 2.1. DAUREKA S.R.L. sells systems, parts and accessories from its catalogue, as described and detailed on its website and in its company documentation (price lists, technical documents, illustrated catalogues, etc.).
- 2.2. DAUREKA S.R.L. reserves the right to make any changes it deems appropriate to its products and items.
- 2.3. It is only possible to purchase items from the catalogue or official company documents current at the time of sending the order and which can also be viewed on the website.
- 2.4. All items are new; DAUREKA S.R.L. does not sell used items or repair same.
- 2.5. Prices, where stated (price list, website, specific conditions agreed with the client, etc.) are given in euro.
- 2.6. All prices are provided without VAT.
- 2.7. Prices are calculated ex works (DAUREKA warehouse). The company reserves the right to add "shipping fees" to the invoice, which will be the same or less than the shipping costs sustained.
- 2.8. Prices are calculated at the time of printing and inclusion on the website. As a result, small adjustments may become necessary due to changes in the price of raw materials or other components. The client will always be informed of price changes before confirmation of order.
- 2.9. Prices include packaging but do not cover on-site assembly.
- 2.10. All deliveries will be accompanied by a fiscal document (invoice or receipt and/or transport document), in accordance with current national law.

## 3. Orders

- 3.1. Orders may be placed as follows:
  - directly, sending the order in writing or completing the purchase order form on the website of DAUREKA S.R.L., to be sent by email to [info@daureka.it](mailto:info@daureka.it)
  - contacting our Sales Divisions, Tel. +587 756407
- 3.2. Telephone orders and verbal orders are not accepted.
- 3.3. On receipt of the order, DAUREKA S.R.L. will send confirmation as acceptance, summarising all terms and conditions of sale.
- 3.4. Receipt of the order from the client is not binding for DAUREKA S.R.L.: sales are concluded when the order confirmation is sent.
- 3.5. Orders sent to DAUREKA S.R.L. cannot be cancelled after two days of receipt of same.
- 3.6. Orders can only be cancelled with the written consent of DAUREKA S.R.L., which in any case reserves the right to charge for any administration and preparation costs.

## 4. Shipping and returns

- 4.1. Materials delivered nationally and for amounts in excess of 500.00 euro will be ex works, using couriers selected by Daureka, unless otherwise agreed with the client.
- 4.2. The shipping and delivery terms for products outside the country will be agreed with the client on a case-by-case basis, as specified on the order confirmation.

## 5. Shipping Times

- 5.1. Products can be dispatched from Monday to Friday on the week stated in the order confirmation.
- 5.2. Shipping times, after the items have been prepared, will be a maximum of 5 working days, except in unforeseeable situations outwith the power of DAUREKA S.R.L..

## 6. Payment method

- 6.1. The following methods of payment are accepted:
- bank transfer: payment must be completed within the terms stated in the invoice, and made to the following IBAN: IT 66 A 02008 70880 000102176253.
  - bank orders within the terms stated in the invoice, from the bank stated by client.

## 7. On delivery of the item

- 7.1. On delivery of the item, the client must check the following:
- that the number of packages corresponds to the number stated in the transport document
  - that there are no breakages or evident dents in the package
  - that the product corresponds to the product ordered
- 7.2. If this is not the case, DAUREKA S.R.L. must be informed of this in due time.

## 8. Withdrawal clause

- 8.1. Clients intending to avail of the withdrawal clause must send, within 5 (five) days from receipt of the package, a registered letter with delivery notification or a certified email stating the wish to avail of the conditions granted by law and details of the product to be returned.
- 8.2. The cost of returning the product will be met by the client who can therefore use the services of the carrier of choice.
- 8.3. A necessary condition for applying the withdrawal clause is in any case that the product and packaging are undamaged. In case the item does not return in the same conditions in which it was received, i.e., in perfect condition, as new and not used, complete with the original packaging and outer packaging, with nothing missing, but it is lacking just one of these essential elements, DAUREKA S.R.L. cannot accept the return and the product will be sent back at the client's expense.
- 8.4. Products purchased at special discount offers cannot be returned or replaced.

## 9. Quality

- 9.1. DAUREKA S.R.L. guarantees that the products provided will comply with the description and specifications stated in the catalogue/price list and/or offer, and/or order confirmation, and/or transport document, and/or invoice.
- 9.2. The purchaser states that they are aware of the nature and use of the goods and acknowledges that the determination of suitability or the suitability of the goods for the use or purpose intended by said purchaser or buyers of same, is the exclusive responsibility of the purchaser.
- 9.3. DAUREKA S.R.L. can provide technical assistance and information that it has available with regard to the use of the items sold and the purchaser will be solely responsible for the results obtained.
- 9.4. The technical characteristic (size, weight, colour, etc.) stated in the catalogue, price list, technical data sheets, and the website of DAUREKA S.R.L. are indicative and may vary during the period of validity of the catalogue; however, the basic characteristics and operation of the product will not be changed.
- 9.5. DAUREKA S.R.L. cannot be held liable for any delay or breach of the obligations set out in these general conditions in the event that said delay or breach results from a case of force majeure or unforeseeable circumstances.

## 10. Warranty

- 10.1. All products sold by DAUREKA S.R.L. are covered by statutory warranty by the manufacturer and for a period of 24 months against non-conformities, pursuant to current law.
- 10.2. The warranty is strictly limited to the replacement of faulty parts
- 10.3. No returns or replacements are accepted without the prior written permission of DAUREKA S.R.L.

## 11. Disputes

- 11.1. Any dispute arising from the interpretation or performance of this agreement will be regulated by the Court of Pisa, with express exclusion of all other courts.

## 1. Premessa

Le presenti condizioni generali di vendita sono pubblicate sui documenti ufficiali di DAUREKA S.R.L. come catalogo, listino, sito web, ecc. Esse sono pertanto ritenute conosciute dal Cliente e ogni ordine ne comporta l'implicita accettazione.

DAUREKA S.R.L. si riserva di diritto di effettuare unilateralmente e insindacabilmente variazioni delle presenti condizioni generali di vendita. Le presenti condizioni sono valide fino all'uscita e pubblicazione di quelle successive ed annullano e sostituiscono ogni altra precedente condizione di vendita.

Il contenuto, i copyright e gli altri diritti sui prodotti e materiali DAUREKA S.R.L. e dei relativi documenti (cataloghi, listini, sito web, ecc.) sono di proprietà di DAUREKA S.R.L..

E' consentito visualizzare, scaricare e riprodurre le informazioni e le schede dei materiali solo per uso interno del Cliente a condizione che:

- siano conservati tutti i contenuti dei documenti ufficiali
- siano utilizzate solo immagini con testo circostante relativo alle immagini
- sia previsto l'avviso di copyright: "© FITLOCK - Tutti i diritti riservati"

Non è consentito eseguire copie, pubblicazioni o usi commerciali diversi da quelli soprelencati senza l'esplicito consenso di DAUREKA S.R.L..

## 2. Prodotti e prezzi

- 2.1. DAUREKA S.R.L. vende sistemi, componenti ed accessori a catalogo come descritti e dettagliati sul proprio sito web e sulla propria documentazione aziendale (listini, documentazione tecnica, cataloghi fotografici, ecc.).
- 2.2. DAUREKA S.R.L. si riserva il diritto di effettuare modifiche ai propri prodotti ed articoli.
- 2.3. E' possibile acquistare solo prodotti presenti nei cataloghi e nella documentazione ufficiale aziendale vigente al momento dell'inoltro dell'ordine e visionabile anche sul sito web.
- 2.4. Tutti gli articoli sono nuovi, non è prevista la vendita di articoli usati né la loro riparazione.
- 2.5. I prezzi, laddove indicati (listino, sito, condizioni particolari con il Cliente, ecc.) sono espressi in euro.
- 2.6. Tutti i prezzi si intendono IVA esclusa.
- 2.7. I prezzi sono calcolati franco magazzino DAUREKA S.R.L., la società si riserva di addebitare in fattura un "contributo spedizione" che sarà comunque uguale o inferiore al costo di spedizione sostenuto.
- 2.8. I prezzi sono calcolati al momento della stampa dei documenti e dell'inserimento sul sito web, di conseguenza sono possibili variazioni di prezzo causate da quello delle materie prime o di altri componenti che saranno sempre comunicate al cliente di fase di conferma d'ordine.
- 2.9. I prezzi si intendono comprensivi di imballo e non comprendono il montaggio in opera.
- 2.10. Ogni consegna e fornitura sarà accompagnata dall'emissione di un documento fiscale (fattura o ricevuta e/o d.d.t.) in accordo alla legislazione nazionale vigente.

## 3. Ordini

- 3.1. La trasmissione degli ordini potrà avvenire:
  - direttamente inviando ordine scritto oppure compilando apposito modulo di ordine di acquisto sul sito DAUREKA S.R.L. da inviare via mail ad [info@daureka.it](mailto:info@daureka.it)
  - rivolgendosi al nostro Ufficio Commerciale Tel. 0587 756407
- 3.2. Non si accettano ordini telefonici né verbali.
- 3.3. Al ricevimento dell'ordine, DAUREKA S.R.L. invierà una conferma d'ordine quale accettazione dell'ordine, riepilogando ogni condizione e termine di vendita.
- 3.4. Il ricevimento dell'ordine da parte del Cliente non è mai impegnativo per DAUREKA S.R.L.: la vendita viene perfezionata con l'invio della conferma d'ordine.
- 3.5. Gli ordini pervenuti in DAUREKA S.R.L. non possono più essere annullati trascorsi 2 giorni dal loro ricevimento.
- 3.6. L'annullamento dell'ordine può avvenire solo dopo consenso scritto da parte di DAUREKA S.R.L. che comunque si riserva il diritto di addebitare eventuali spese per la gestione dell'ordine e la sua preparazione.

## 4. Resa e modalità di spedizione

- 4.1. Le consegne dei materiali sul territorio nazionale per quantità superiori a 500,00 Euro saranno effettuate in porto franco con l'utilizzo di corrieri selezionati da DAUREKA S.R.L. fatti diversi accordi con il Cliente.
- 4.2. I termini di consegna e spedizione di prodotti sul territorio extra nazionale sono concordati con il Cliente di volta in volta e specificati sulla conferma d'ordine

## 5. Tempi di spedizione

- 5.1. Le spedizioni dei prodotti vengono effettuate dal lunedì al venerdì della settimana indicata sulla conferma d'ordine.
- 5.2. I tempi per la spedizione dopo avere predisposto i prodotti sono al massimo di 5 giorni lavorativi, fatte salve diverse imprevedibili situazioni non dipendenti da DAUREKA S.R.L..

## 6. Modalità di pagamento

- 6.1. Sono accettate le seguenti forme di pagamento:
  - a mezzo Bonifico Bancario: il pagamento dovrà essere eseguito nei termini indicati in fattura al seguente indirizzo  
IBAN: IT 66 A 02008 70880 000102176253.
  - a mezzo R.I.BA. nei termini indicati in fattura sulla banca indicata dal cliente.

## 7. Al ricevimento prodotto

- 7.1. Alla ricezione del prodotto, il Cliente deve verificare:
  - che il numero dei colli indicato sul d.d.t. sia corrispondente al numero di colli effettivamente consegnato
  - che siano assenti rotture del pacco o ammaccature evidenti
  - che il prodotto sia corrispondente a quanto effettivamente ordinato
- 7.2. In caso di difformità dovrà essere avvertita tempestivamente DAUREKA S.R.L.

## 8. Diritto di recesso

- 8.1. Il cliente che intenda esercitare il diritto di recesso deve inviare, entro 5 (cinque) giorni dalla ricezione del pacco, una raccomandata con avviso di ricevimento o una mail di posta certificata, contenente la manifestazione di volontà di avvalersi dei benefici concessi dalla legge e l'indicazione del prodotto che intende restituire.
- 8.2. Le spese di restituzione del prodotto sono a carico del cliente che potrà quindi scegliere il vettore che preferisce.
- 8.3. Condizione necessaria per l'esercizio del diritto di recesso è comunque la sostanziale integrità del prodotto e della confezione. Nel caso in cui l'oggetto non ritorni nelle medesime condizioni di ricezione, e cioè in perfetto stato di conservazione, non usato, provvisto dell'imballo originale, dell'imballo esterno, senza alcuna mancanza, ma invece venga restituito carente di anche uno solo dei detti caratteri essenziali, DAUREKA S.R.L. non potrà accettare il reso e il prodotto verrà rispedito a carico del cliente.
- 8.4. I prodotti acquistati con sconto speciale non possono essere restituiti o sostituiti.

## 9. Qualità

- 9.1. DAUREKA S.R.L. garantisce che i prodotti forniti saranno conformi alla descrizione o alle specifiche riportate a fronte del relativo catalogo / listino prezzi e/o offerta, e/o conferma d'ordine e/o bolla di accompagnamento e/o fattura.
- 9.2. L'acquirente dichiara di conoscere la natura e l'uso della merce e riconosce che la determinazione dell'idoneità o idoneità della merce per l'uso o lo scopo previsto da lui o dai suoi acquirenti è di esclusiva responsabilità dell'acquirente stesso.
- 9.3. DAUREKA S.R.L. può fornire l'assistenza tecnica e le informazioni che ha a disposizione relativamente all'uso dei beni venduti e l'acquirente si assume la responsabilità esclusiva dei risultati ottenuti.
- 9.4. Le caratteristiche tecniche (dimensioni, pesi, colori, ecc.) indicate sul catalogo, sul listino, sulle schede tecniche, sul sito web di DAUREKA S.R.L. sono da ritenersi indicative e potranno variare durante il periodo di validità del catalogo, a condizione che le caratteristiche di base e la funzionalità del prodotto non vengano modificate.
- 9.5. DAUREKA S.R.L. non si ritiene responsabile per qualsiasi ritardo o inadempimento agli obblighi previsti dalle presenti condizioni generali qualora il ritardo o l'inadempimento derivino da caso fortuito o da cause di forza maggiore.

## 10. Garanzie

- 10.1. Tutti i prodotti venduti da DAUREKA S.R.L. sono coperti dalla garanzia convenzionale del produttore e dalla garanzia di 24 mesi per difetti di conformità, ai sensi della normativa vigente.
- 10.2. La garanzia è strettamente limitata alla sostituzione di pezzi difettosi.
- 10.3. Non vengono accettati resi e sostituzioni di prodotti se non dopo preventiva autorizzazione scritta da parte di DAUREKA S.R.L.

## 11. Controversie

- 11.1. Qualsiasi controversia relativa all'interpretazione o all'esecuzione del contratto sarà devoluta al Foro competente di Pisa con espressa esclusione di ogni altro Foro.

# FITLOCK

*FIT YOUR NEEDS, GET OUR SYSTEM*

FITLOCK® · FITKITE® · FITPAN® · FITFLOOR® · FITJUMP®  
FITGRID® · FITCLOCK® · FITBLOCK®

Fitlock is a registered trademark by:

**DAUREKA**

Via L. Fibonacci 924  
56031 Bientina (Pisa), Italy  
Phone +39 0587 755931 · Fax +39 0587 756180  
fitlock.it · info@fitlock.it

**NOTICE:** The above information and provisions, although reflecting our best experience, shall be deemed as merely indicative and shall be confirmed by exhaustive practical applications. Therefore, before using the product, those who intend to use it shall determine whether it is suitable for its intended use and anyway shall undertake all responsibility resulting from its use.